

MUDROOM 2 – BY KITCHEN

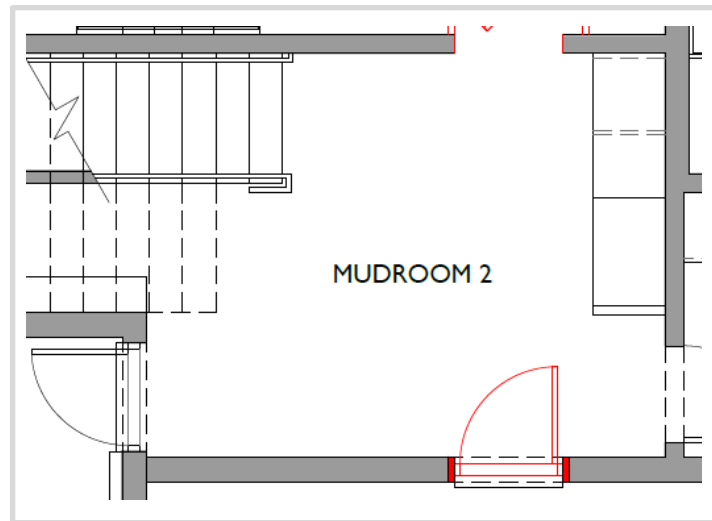

FLOOR PLAN

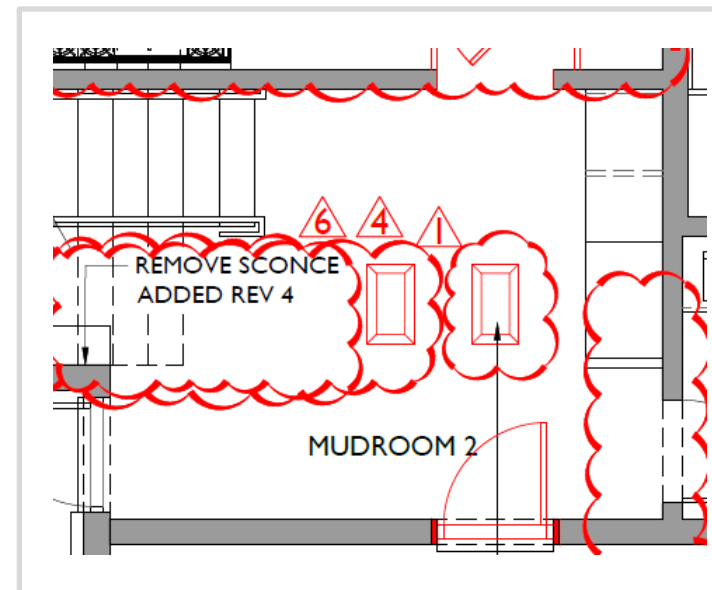

LIGHTING PLAN



MAIN FLOOR
QUARTZ HARMONY PORCELAIN
TILE
24" X 48"



COUNTERTOP AT MUDROOM
BUILT IN DRAWER TOP

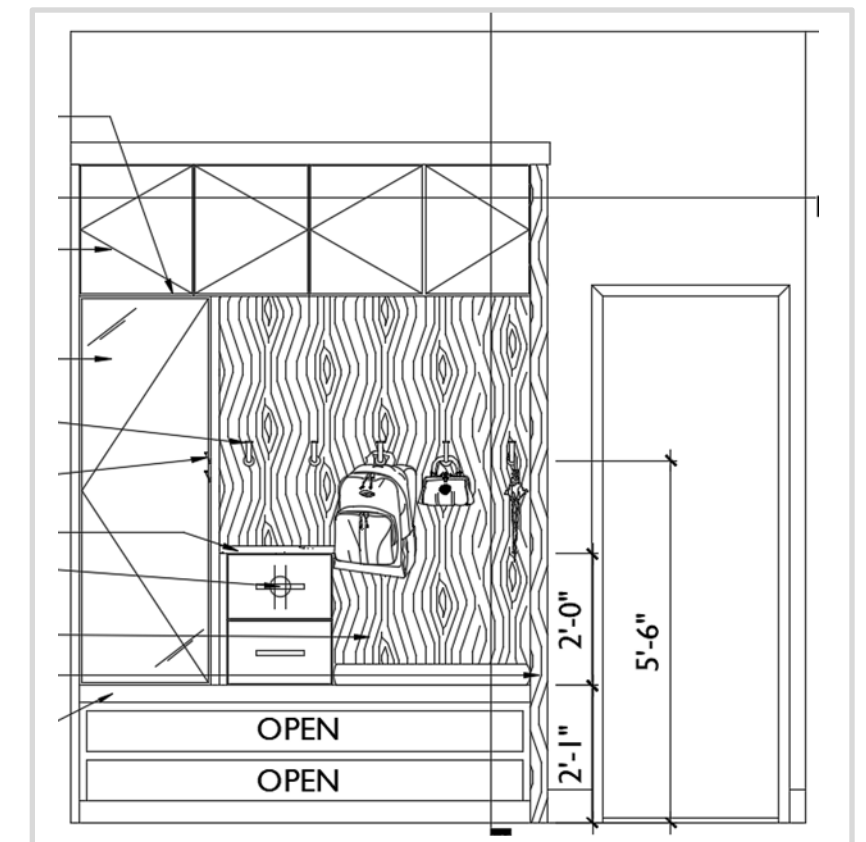

ELEVATION OF MUDROOM BUILT-IN

KITCHEN POWDER BATH

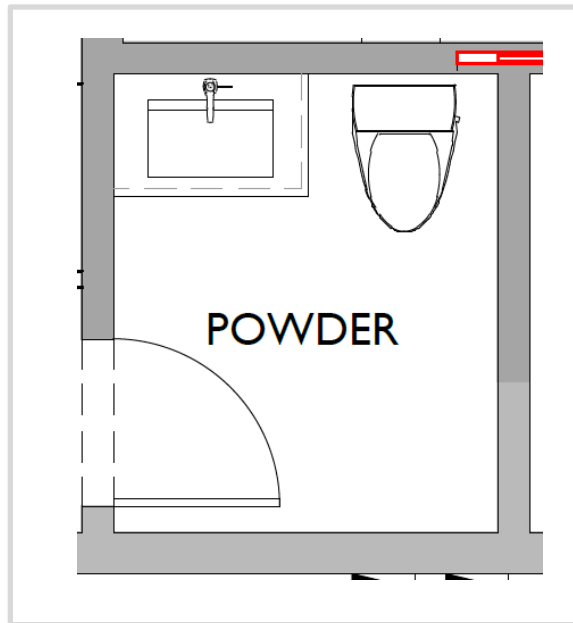

POWDER

FLOOR PLAN

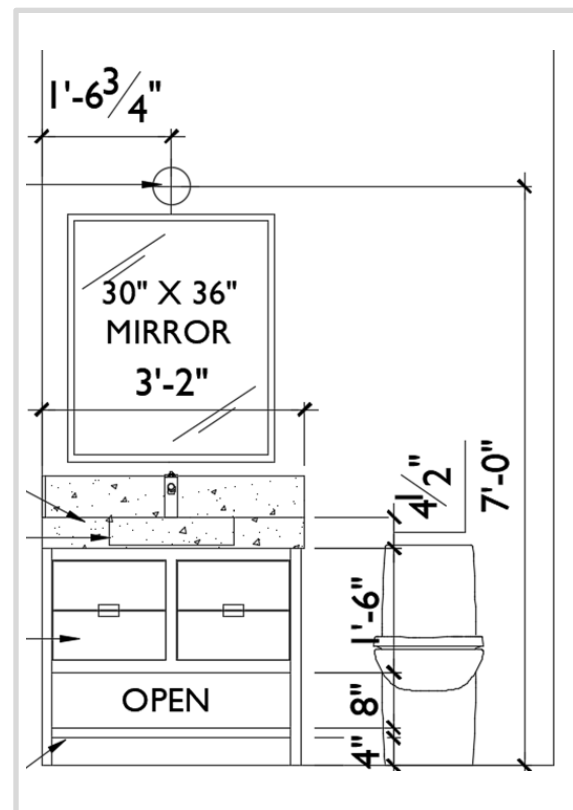

ELEVATION

SCONCE
WHITE STRIE GLASS WITH
POLISHED NICKEL FINISH
12" DIA



MIRROR
FINISH: POLISHED NICKEL
23" W X 35" H

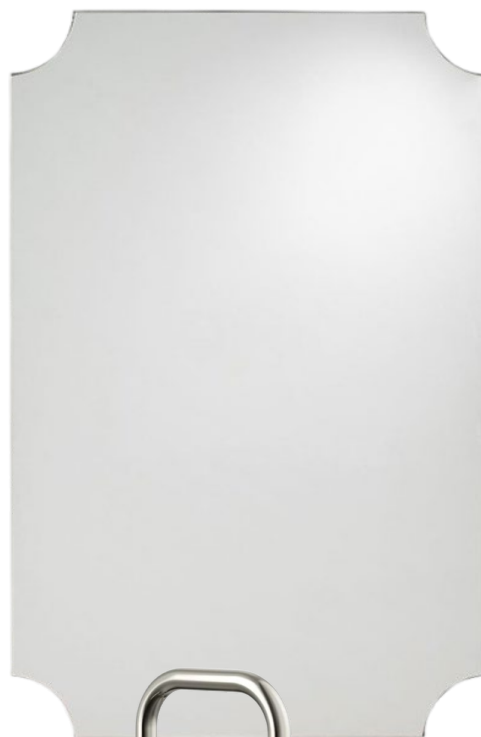

PLUMBING
FIXTURES
WHITE



WALLS, CEILING & TRIM
SW ORIGAMI WHITE



MAIN FLOOR
QUARTZ HARMONY PORCELAIN
TILE
24" X 48"



COUNTERTOP

DINING ROOM

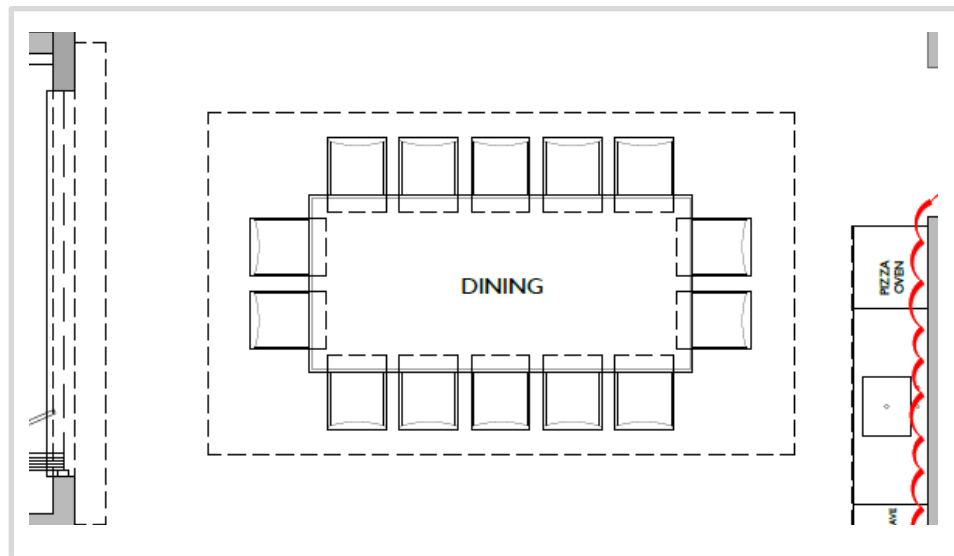

FURNITURE PLAN



CEILING AND WALLS
SW ORIGAMI WHITE

WOOD FLOOR
10" PLANK



DINING TABLE
144"W X 66"D X 30"H

DINING CHAIRS (X14)
22"W X 28"D X 37"H



WOOD PARQUET FLOORING

GREAT ROOM

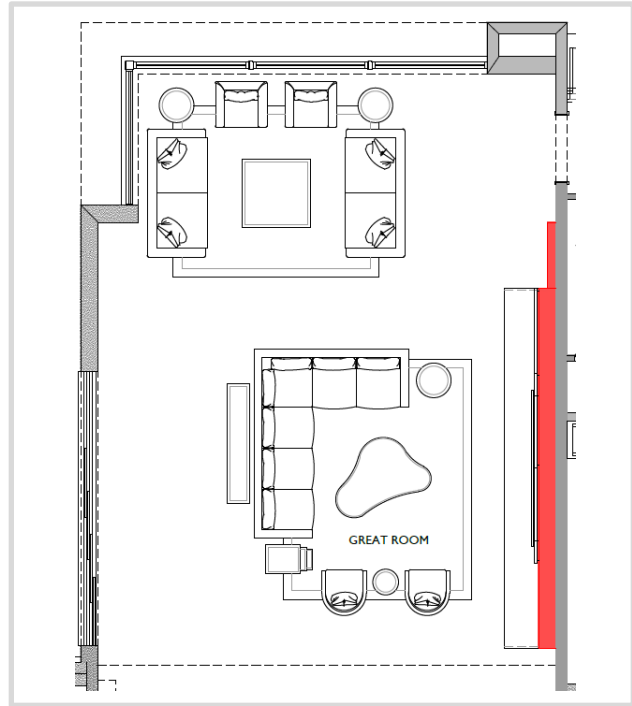

FLOOR PLAN

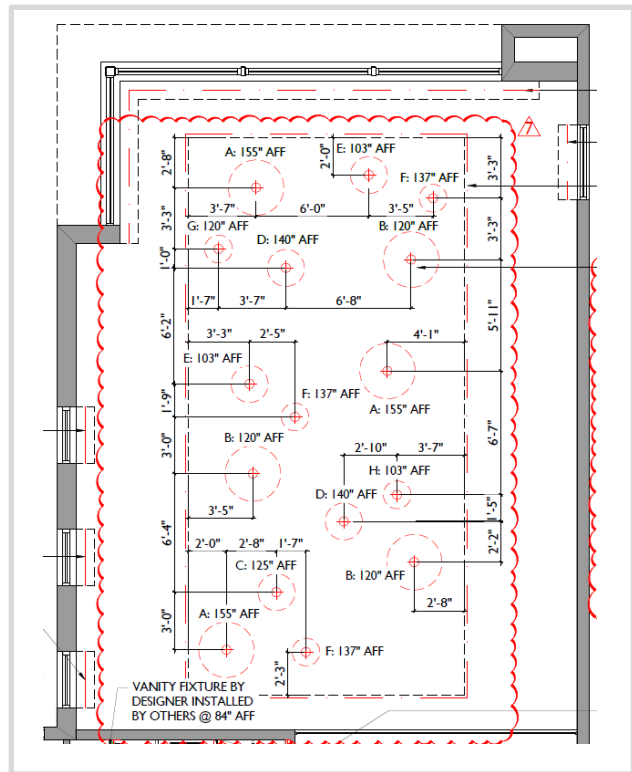

LIGHTING PLAN

ELEVATION OF GREAT ROOM WALL

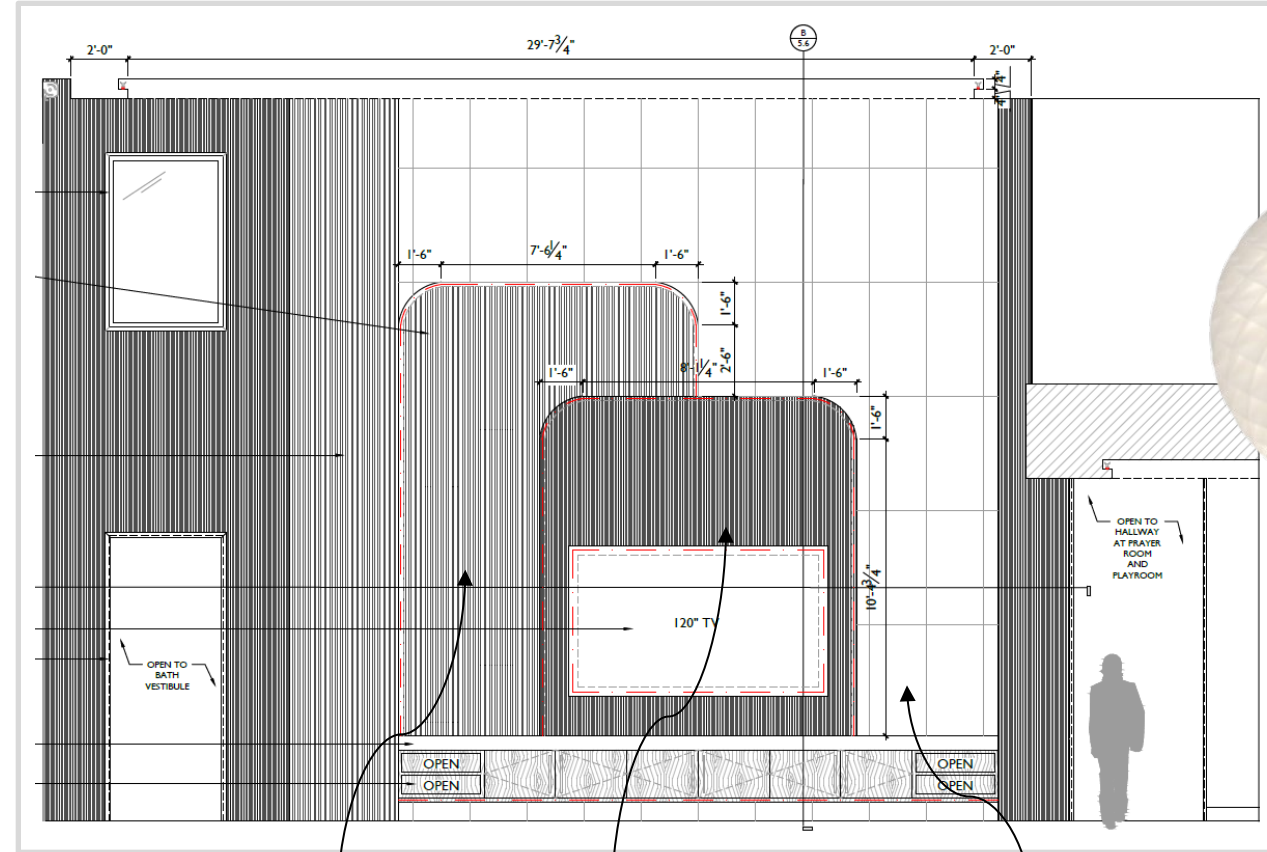

FLUTED STONE
DETAIL
LARGER SPACING



FLUTED STONE
DETAIL
TIGHTER SPACING



SOLID STONE AT
WALL



COVE CEILING
WALLCOVERING

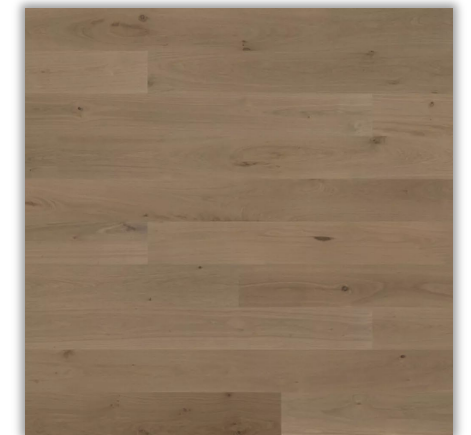

WOOD FLOOR
FRENCH OAK
10" W PLANK



PENDANTS
17" x 5
24" x 5
36" x 6
TOTAL OF 16 PENDANTS

GREAT ROOM - AT BUILT-IN AREA

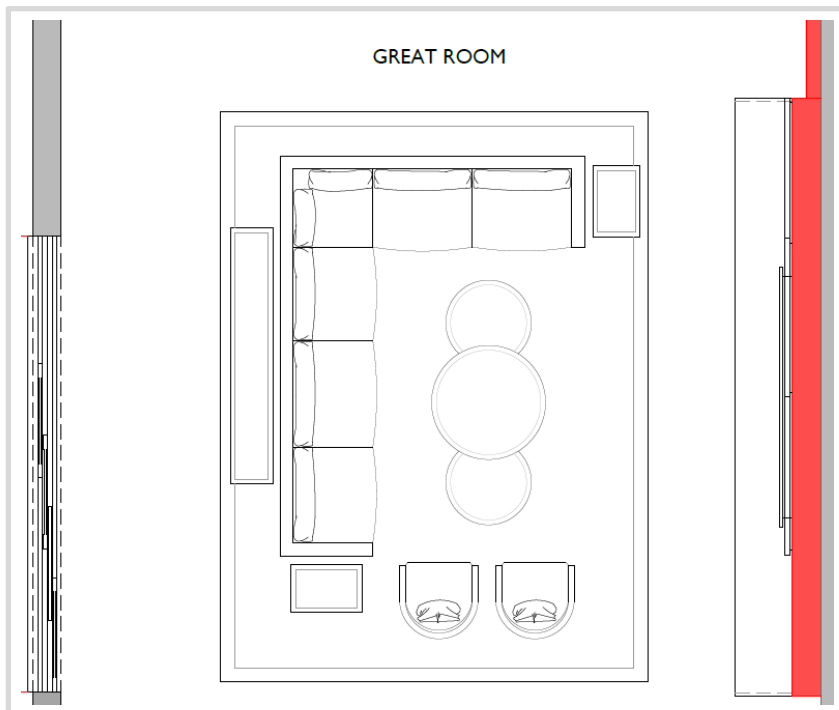

FURNITURE PLAN



CEILING AND WALLS
SW ORIGAMI WHITE



SOFA FABRIC BASE FINISH

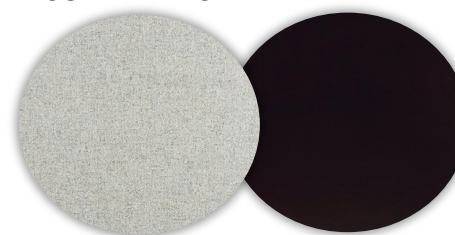

PILLOWS
(X3) 22" X 22"
(X3) 20" X 20"



CHAIR FABRIC



SIDE TABLE (X2)
(DRAWERS FACING OUTWARDS)
30"W X 20"D X 24"H



ACCENT CHAIR (X2)
33"W X 32"D X 30.5"H



SLOPE ARM SECTIONAL
14.5'W X 40"D X 31"H



COCKTAIL TABLES - SET OF 3
(1) 48" DIA X 16"H
(2) 36" DIA X 12.75"H

RUG & RUG PAD
20" X 15"

GREAT ROOM - AT WINDOW

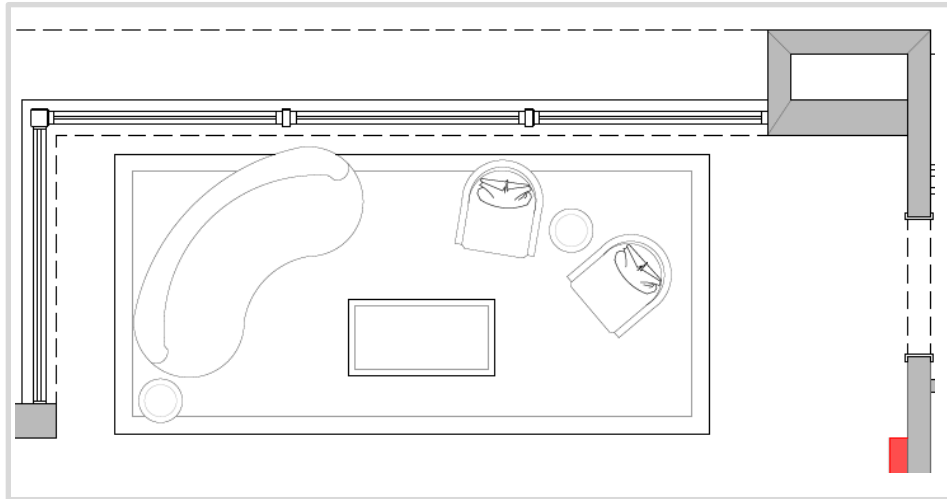

FURNITURE PLAN

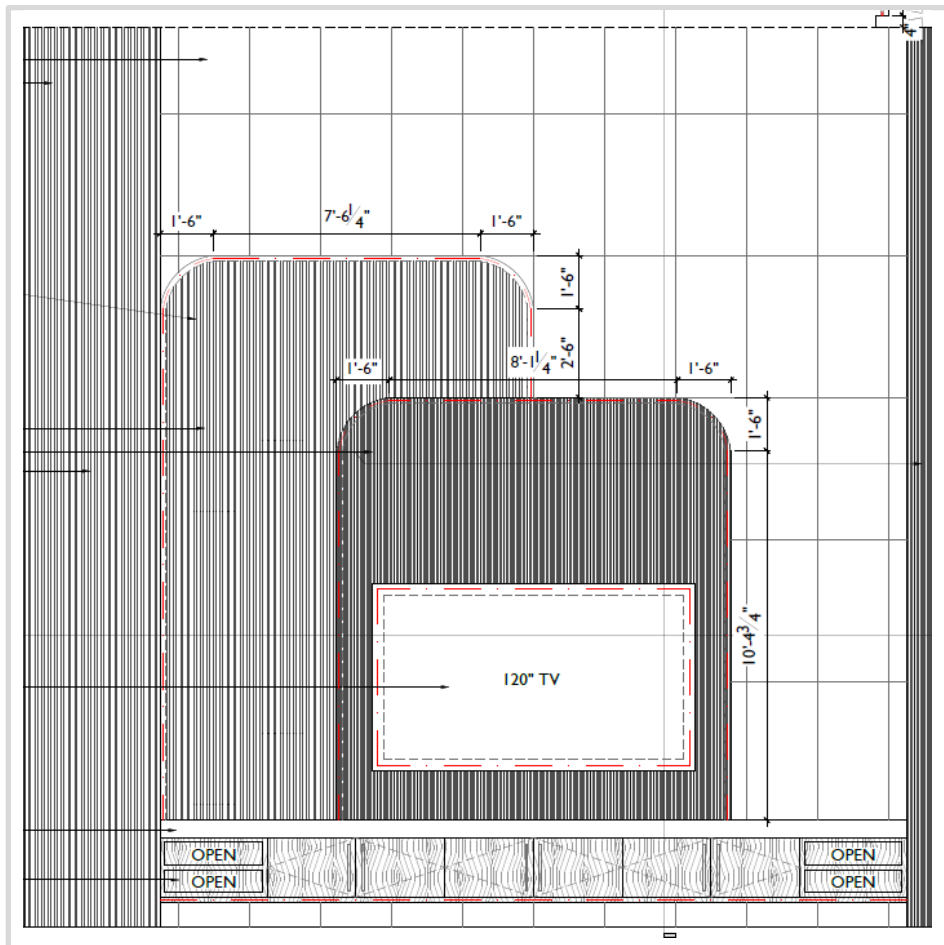

GREAT ROOM WALL ELEVATION



SOFA FABRIC

SOFA
96"W X 46"D X 31"H

PILLOW
(X2) 18" X 12"

CEILING AND WALLS
SW ORIGAMI WHITE

WOOD FLOOR
10" PLANK

CHAIR FABRIC

ACCENT CHAIRS
(X2)
27.5"W X 32"D X
33"H

SIDE TABLES (X2)
15"DIA X 21.25"H

COCKTAIL TABLE
50"W X 26"D X 18"H

RUG & RUG PAD
8' X 17'

POOL BATH

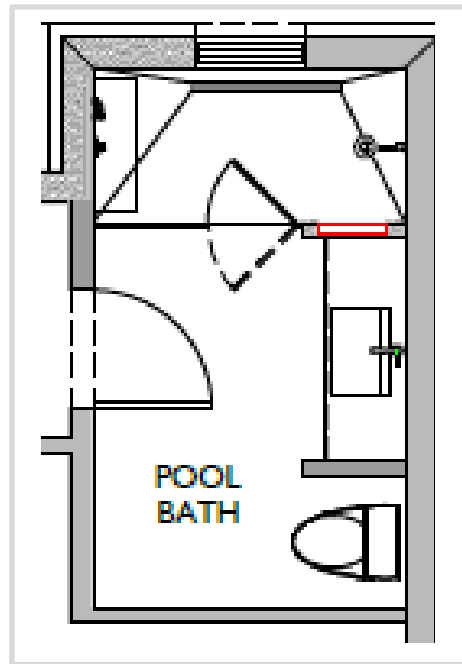

FLOOR PLAN

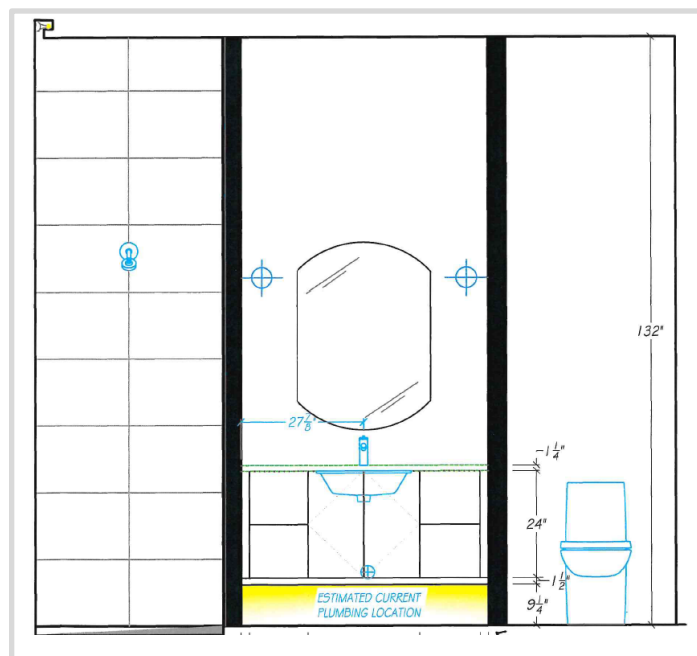

ELEVATION



COUNTERTOP

WALLS, CEILING & TRIM
SW ORIGAMI WHITE

MAIN FLOOR
PREMIUM WHITE
HONED 15" X 30"

VANITY SCNCE
LINEAR SCNCE IN A
POLISHED NICKEL FINISH
QTY: 2 AT EITHER SIDE
OF MIRROR

MIRROR
FINISH: POLISHED NICKEL
30"W X 42"H

SHOWER WALLS
PREMIUM WHITE
POLISHED 15 X 30



SHOWER FLOOR
PREMIUM WHITE
HONED 15" X 30"
CUT TO 6" X 10"



MULTIPURPOSE ROOM 1 (PREVIOUSLY KIDS ROOM)

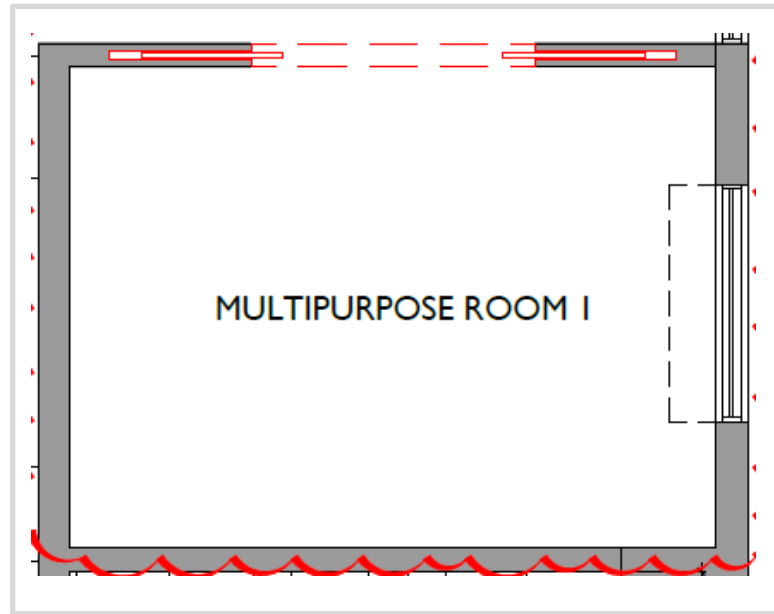

FLOOR PLAN

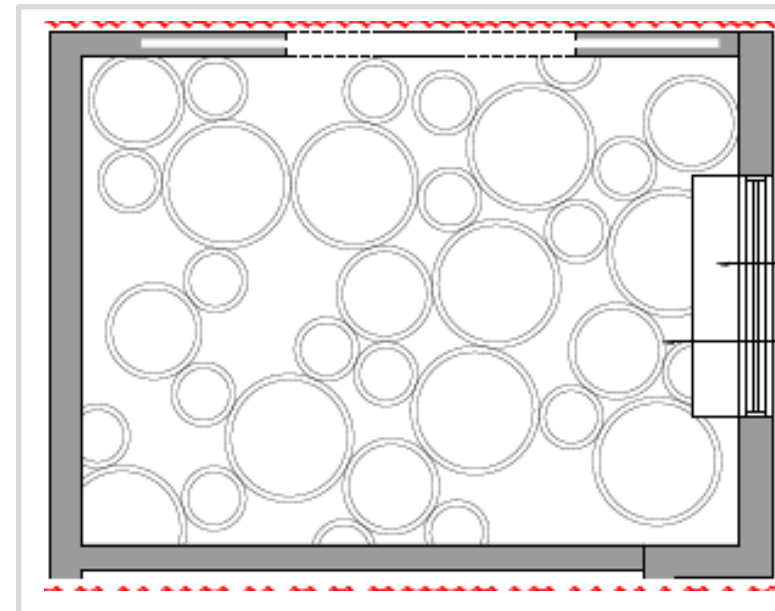

CEILING DETAIL



CEILING FAN
60" W
WHITE FINISH
NO LIGHT KIT
QTY: 1

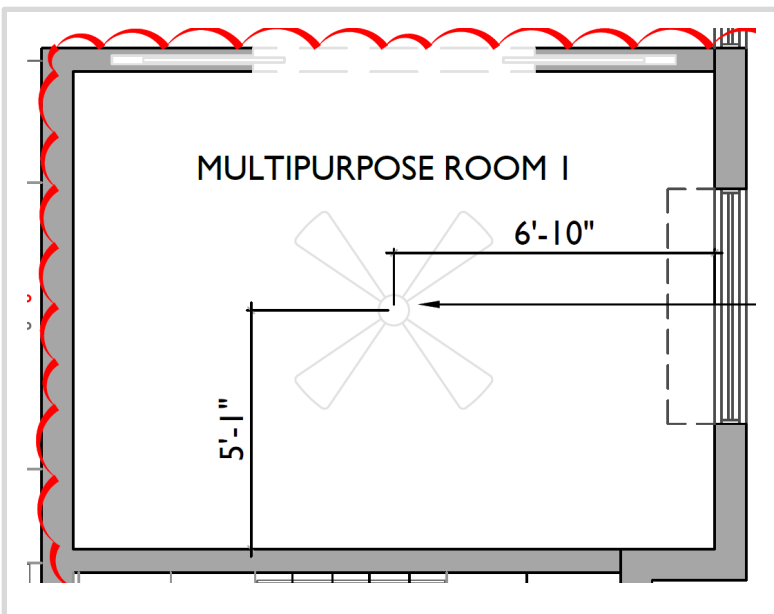

LIGHTING PLAN



WOOD FLOOR
FRENCH OAK
10" W PLANK

MULTIPURPOSE ROOM 2 (PREVIOUSLY PRAYER ROOM)

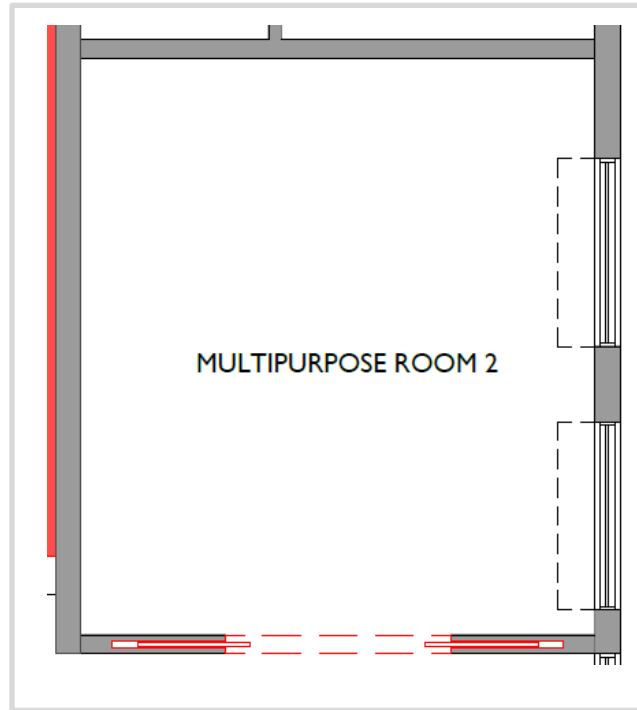

FLOOR PLAN

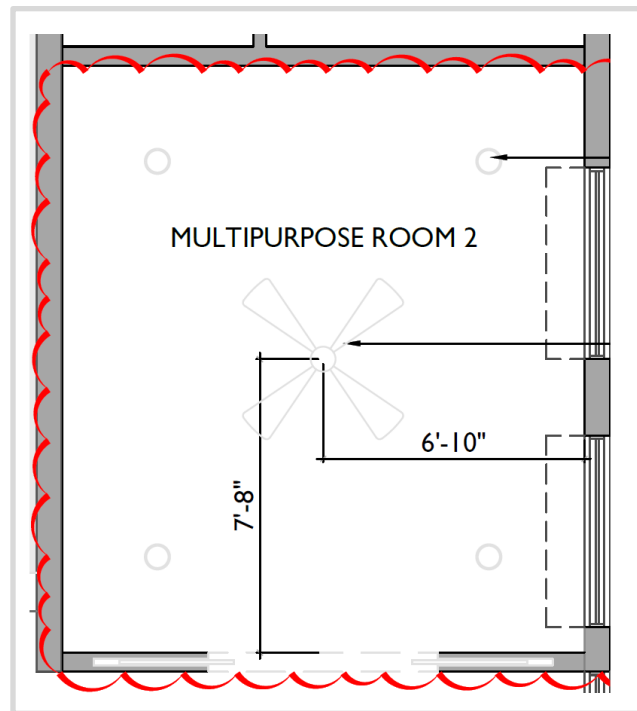

LIGHTING PLAN



CEILING FAN
60" W
WHITE FINISH
NO LIGHT KIT
QTY: 1



WOOD FLOOR
FRENCH OAK
10" W PLANK

POWDER BATH 1 - BY STUDY

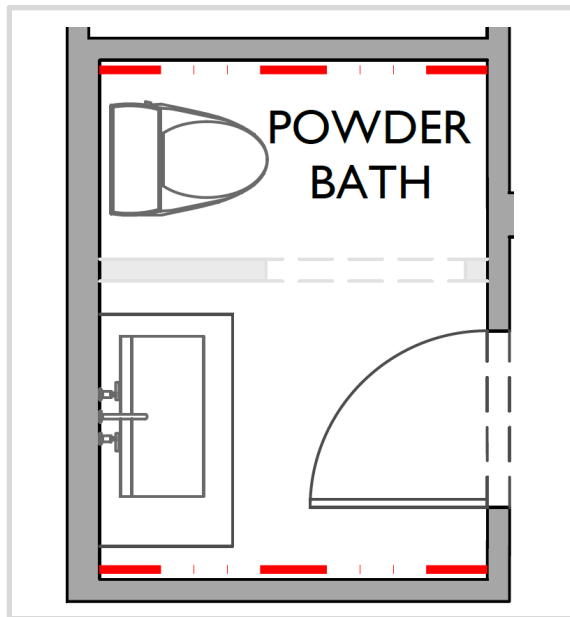

FLOOR PLAN

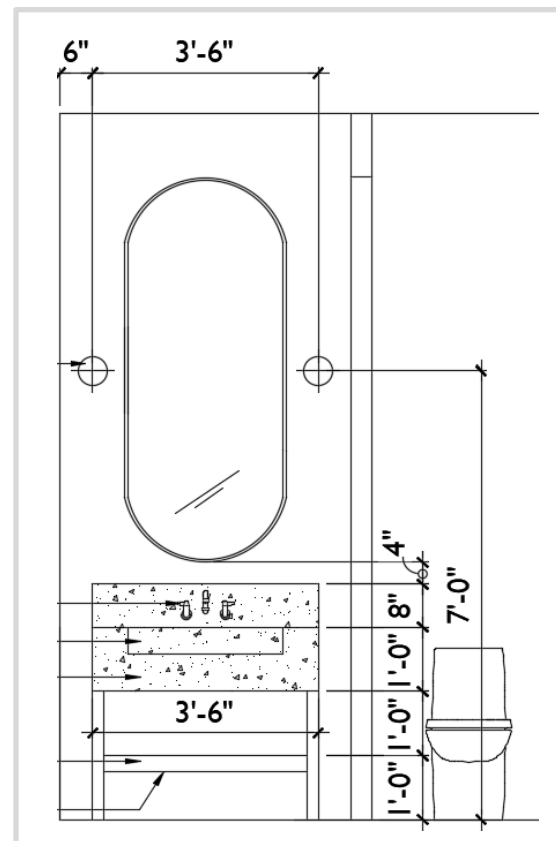

ELEVATION

